

"Lock and shield" mounting, line switch, fuseh. 5x20 mm with/without voltage sel. (series-parallel)

Standard- or Medical-Filter

Snap-In Version
GRM4: with shield and line filterC14

70° C**Description**

- Panel Mount:
Snap-In Version from rear-side
- 5 Functions:
Inlet Protection class I, Line switch 2-pole, with or without Fuseholder for fuse-links 5 x 20 mm, with or without voltage selector, Line filter in standard and medical version
- On phase-out, not recommended for new design

Approvals

- VDE License Number: 118913
- UL License Number: E72928
- CSA License Number: 701867

Characteristics

- Ultra-compact design
Time saving "Lock and Shield" snap-in design for rear-panel mounting
- All single elements are already wired
- Fuseholder on the inside of the equipment prevents accidental use of incorrect fuse-links by the user
- Voltage selector for two voltage ranges
Innovative EMC-shielding with flexible steel segments for an excellent contact to the panel
- Insulation cover on the rear-side
- Qualified for use in equipment according IEC/EN 60950

Other versions on request

- Panel thickness 1.0 / 2 / 2.5 mm (max.)
- Fuseholder 1-pole
- Line switch 1-pole
- Voltage selector with other marking

References[General Product Information](#)**Weblinks**[Approvals](#), [RoHS](#), [CHINA-RoHS](#), [e-Store](#), [SCHURTER-Stock-Check](#), [Distributor-Stock-Check](#)**Technical Data**

Ratings IEC	0.5 - 10A @ Ta 40 °C / 250VAC; 50Hz	Appliance-Inlet /-Outlet	C14 acc. to IEC/EN 60320-1, UL 498, CSA C22.2 no. 42 (for cold condition) pin-temperature 70 °C, 10A, Protection class I
Ratings UL/CSA	0.5 - 10A @ Ta 40 °C / 125VAC; 60Hz	Fuseholder	1 or 2 pole, Shocksafe category PC2 acc. to IEC 60127-6, for fuse-links 5 x 20mm
Leakage Current	standard < 0.5 mA (250 V / 60Hz) medical < 5 µA (250 V / 60 Hz)	Rated Power Acceptance @ Ta 23 °C	5 x 20: 2W (1 pole)/ 1.6W (2-pole) per pole
Dielectric Strength	> 1.7 kVDC between L-N > 2.7 kVDC between L/N-PE Test voltage (2 sec)	Power Acceptance @ Ta > 23°C	Admissible power acceptance at higher ambient temperature see derating curves
Allowable Operation Temp.	-25 °C to 85 °C	Line Switch	Rocker switch 2-pole, non-illuminated, acc. to IEC 61058-1 Technical details
Climatic Category	25/085/21 acc. to IEC 60068-1	Voltage selector	optional, jumper, 2 digits
Degree of Protection	from front side IP 40 acc. to IEC 60529	Line Filter	Standard and Medical Version, IEC 60939, IEC 60601-1, UL 1283, UL 544, EN 133 200, CSA C22.2 no. 8 Technical details
Protection Class	Suitable for appliances with protection class I acc. to IEC 61140	MTBF	> 1'400'000h acc. to MIL-HB-217 F
Terminal	Quick connect terminals 4.8 x 0.8 mm Solder terminal on request Solder terminals for voltage selector		
Panel Thickness s	Snap-in: 1.5 mm (other on request)		
Material: Housing	Thermoplastic, black, UL 94V-0		

Dimensions

GRM4

Length |-----| 48.3 mm

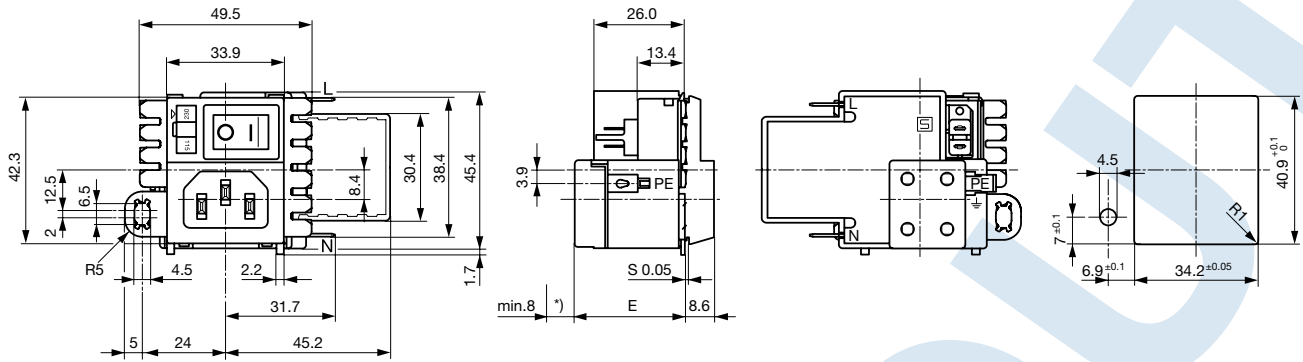

E = 31.7 mm with fuseholder

E = 26.25 mm without fuseholder

*) Min. space to remove the fuseholder cover

Technical Data of Filter-Components

Rated Current [A]	Filter-Type	Inductances L [mH]	Capacitance CX [nF]	Capacitance CY [nF]	R [MΩ]
0.5	Standard Version	2 x 24	100	2.2	-
1	Standard Version	2 x 12	100	2.2	-
3	Standard Version	2 x 2.5	100	2.2	-
6	Standard Version	2 x 0.78	100	2.2	-
10	Standard Version	2 x 0.225	100	2.2	-
0.5	Medical Version (M5)	2 x 24	100	-	1
1	Medical Version (M5)	2 x 12	100	-	1
3	Medical Version (M5)	2 x 2.5	100	-	1
6	Medical Version (M5)	2 x 0.78	100	-	1
10	Medical Version (M5)	2 x 0.225	100	-	1

Dimensions

Step 1

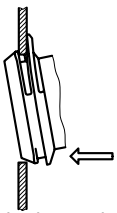

Place the socket in top edge of the panel cut-out.

Step 2

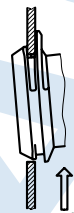

Push the socket upwards.

Step 3

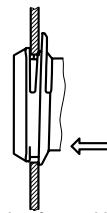

Push the socket forward into the panel cut-out.

Step 4

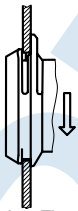

Release the socket. The component is self adjusting.

Diagrams

Voltage selector

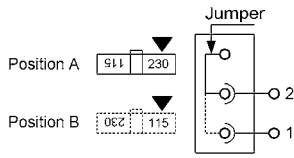

GRM4 Standard version

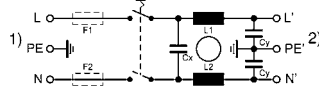

- 1) Line
- 2) Load

GRM4 Medical version

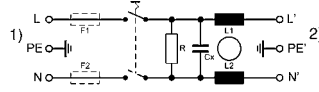

- 1) Line
- 2) Load

Derating Curves

1-pole

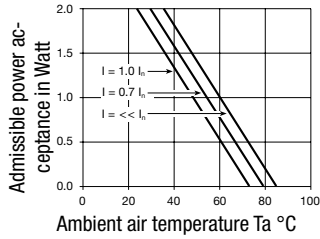

2-pole

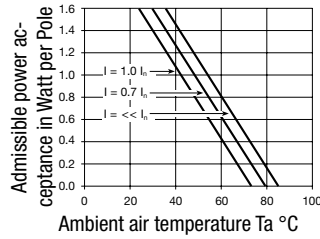

Attenuation Loss

Standard version

0.5 A

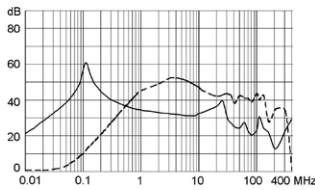

1 A

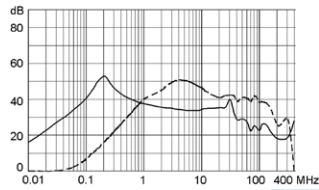

3 A

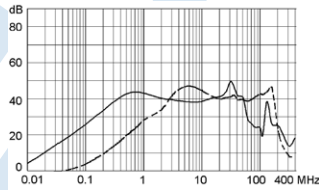

6 A

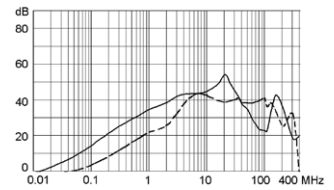

10 A

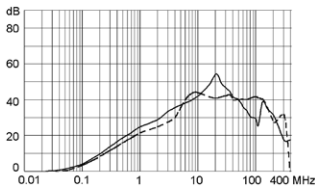

Medical version (M5)

0.5 A

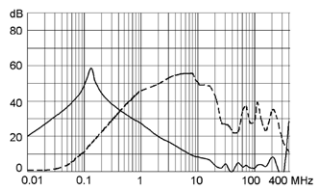

1 A

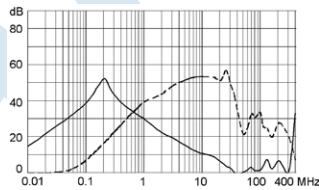

3 A

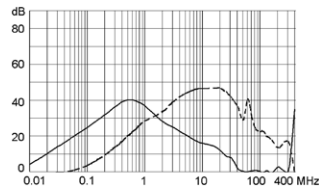

6 A

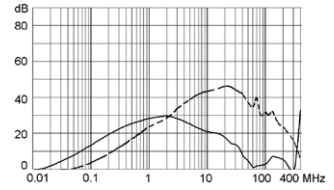

10 A

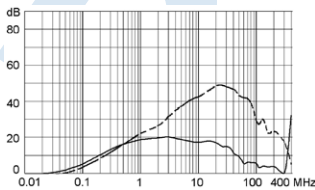

--- differential mode ____ common mode

Variants

Basic version:

- Marking of the voltage selector 115/230
- with housing and cover on the rear-side

Rated Current [A]	Filter-Type	Fuseholder	Line Switch	Voltage selector	Order Number
6	Standard Version	-	1 pole	●	GRM4.4401.013
0.5	Standard Version	-	2-pole		GRM4.4102.013
0.5	Standard Version	-	2-pole	●	GRM4.4102.123
1	Standard Version	-	2-pole	●	GRM4.4202.013
1	Standard Version	-	2-pole	●	GRM4.4202.123
3	Standard Version	-	2-pole	●	GRM4.4302.013
3	Standard Version	-	2-pole	●	GRM4.4302.123
6	Standard Version	-	2-pole	●	GRM4.4402.013
6	Standard Version	-	2-pole	●	GRM4.4402.123
10	Standard Version	-	2-pole	●	GRM4.4502.013
10	Standard Version	-	2-pole	●	GRM4.4502.123
0.5	Standard Version	2-pole	2-pole	●	GRM4.4122.013
0.5	Standard Version	2-pole	2-pole	●	GRM4.4122.123
1	Standard Version	2-pole	2-pole	●	GRM4.4222.013
1	Standard Version	2-pole	2-pole	●	GRM4.4222.123
3	Standard Version	2-pole	2-pole	●	GRM4.4322.013
3	Standard Version	2-pole	2-pole	●	GRM4.4322.123
6	Standard Version	2-pole	2-pole	●	GRM4.4422.013
6	Standard Version	2-pole	2-pole	●	GRM4.4422.123
10	Standard Version	2-pole	2-pole	●	GRM4.4522.013
10	Standard Version	2-pole	2-pole	●	GRM4.4522.123
0.5	Medical Version (M5)	-	2-pole	●	GRM4.5102.013
0.5	Medical Version (M5)	-	2-pole	●	GRM4.5102.123
1	Medical Version (M5)	-	2-pole	●	GRM4.5202.013
1	Medical Version (M5)	-	2-pole	●	GRM4.5202.123
3	Medical Version (M5)	-	2-pole	●	GRM4.5302.013
3	Medical Version (M5)	-	2-pole	●	GRM4.5302.123
6	Medical Version (M5)	-	2-pole	●	GRM4.5402.013
6	Medical Version (M5)	-	2-pole	●	GRM4.5402.123
10	Medical Version (M5)	-	2-pole	●	GRM4.5502.013
10	Medical Version (M5)	-	2-pole	●	GRM4.5502.123
0.5	Medical Version (M5)	2-pole	2-pole	●	GRM4.5122.013
0.5	Medical Version (M5)	2-pole	2-pole	●	GRM4.5122.123
1	Medical Version (M5)	2-pole	2-pole	●	GRM4.5222.013
1	Medical Version (M5)	2-pole	2-pole	●	GRM4.5222.123
3	Medical Version (M5)	2-pole	2-pole	●	GRM4.5322.013
3	Medical Version (M5)	2-pole	2-pole	●	GRM4.5322.123
6	Medical Version (M5)	2-pole	2-pole	●	GRM4.5422.013
6	Medical Version (M5)	2-pole	2-pole	●	GRM4.5422.123
10	Medical Version (M5)	2-pole	2-pole	●	GRM4.5522.013
10	Medical Version (M5)	2-pole	2-pole	●	GRM4.5522.123

Packaging unit 120 Pcs